

NG3/650
Tank 88,08 kg

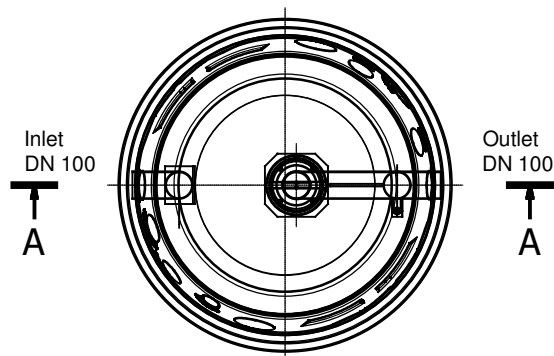

ACO Separatori

ACO separator naftnih derivata Oleopator P NG 3 SF 650

Napomena: Potrebno odabrati odgovarajući pokrovni element sa poklopcem

Artikl br.:
3913.80.00

ACO d.o.o.

Ismeta Alajbegovića Šerbe 12

Tel. + 387 33 768 910

Fax. + 387 33 768 911

www.aco.ba ; email: aco@aco.ba

