

NG3/300
Tank 73,20 kg

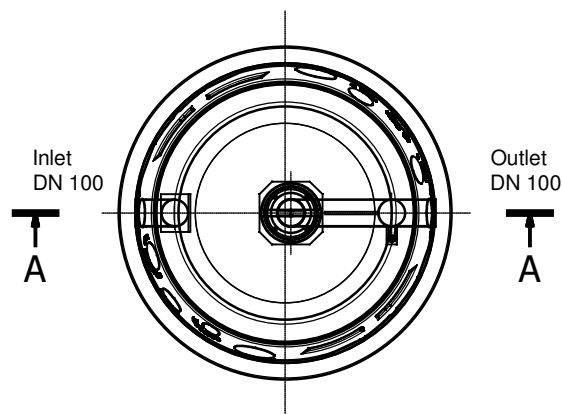

ACO Separatori

ACO separator naftnih derivata Oleopator P NG 3 SF 300

Napomena: Potrebno odabrati odgovarajući pokrovni element sa poklopcem

Artikl br.:
3903.80.00

ACO d.o.o.
Ismeta Alajbegovića Šerbe 12
Tel. + 387 33 768 910
Fax. + 387 33 768 911
www.aco.ba ; email: aco@aco.ba

