

A-A (M 1:X)

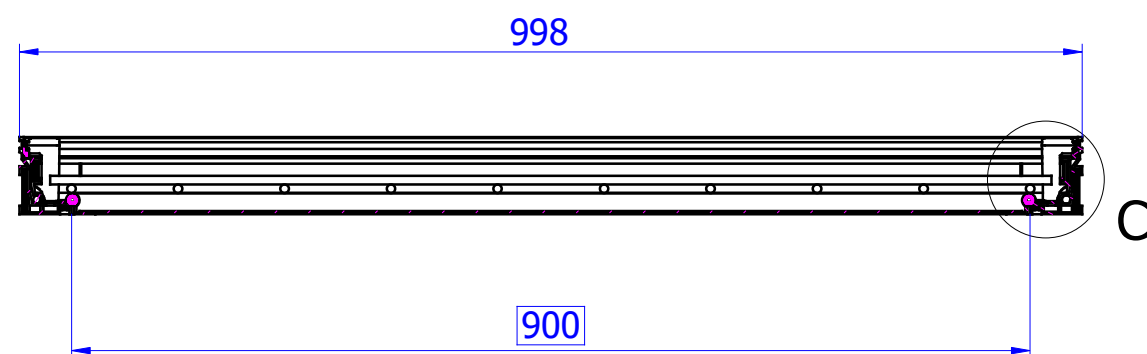

B-B (M 1:X)

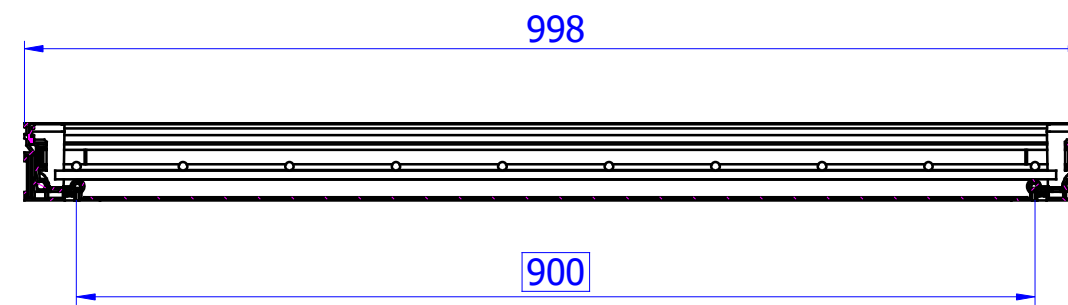

D-D (M 1:X)

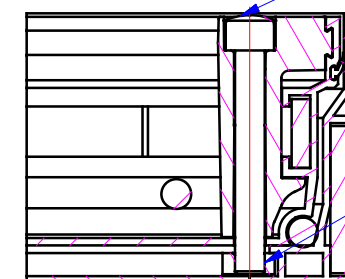

C (M1:X)

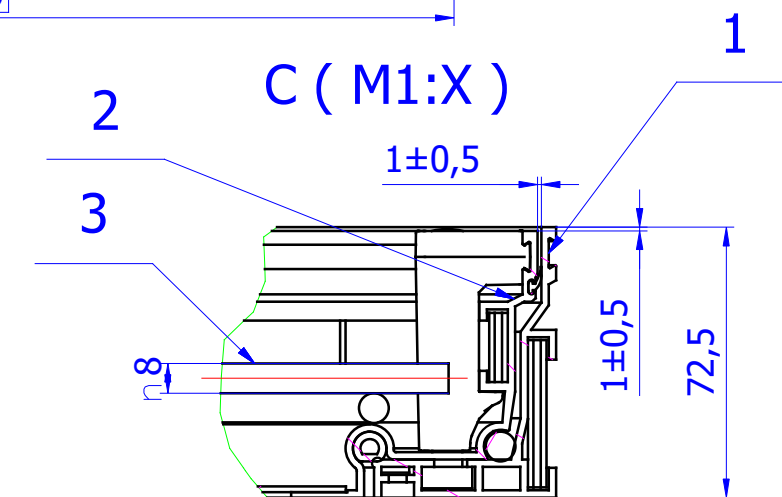

ACO Poklopci za ispunu

ACO TopTeK poklopac, aluminijum; klasa 50 kN/L15, 900x900mm.

poklopac za ispunu i ugradnju odabrane završne obloge (kamene ploče, betonske ploče, keramika...)
 Vodotjesan/plinotjesan.
 Gradjevinske dimenzije rama 998x998x72,5mm
 Svijetli otvor poklopca 900x900mm.
 Raspoloživa visina za završnu oblogu je 15 mm.
 Materijal aluminij.
 Klasa opterećenja 50 kN/L15 prema BAS EN 124.
 Sa priborom za otvaranje.
 Težina: 19,87 kg.
 Isporuka i ugradnja prema uputama proizvođača.

Artikl br.:
406627

ACO d.o.o.
 Ismeta Alajbegovića Šerbe 12
 Tel. + 387 33 768 910
 Fax. + 387 33 768 911
 www.aco.ba ; email: aco@aco.ba

